



RT 1045

45t capacity class
Rough terrain crane
Datasheet
metric



RT 1045

WORKS FOR YOU.™

RANGE GRAPH – MAIN BOOM

RT 1045

CAMPO DI PORTATA · ARBEITSBEREICH · DIAGRAMME DE CHARGE ·
DIAGRAMA DE CARGA · GRÁFICO DE ALCANCE · ДИАГРАММА РАБОЧЕЙ ЗОНЫ

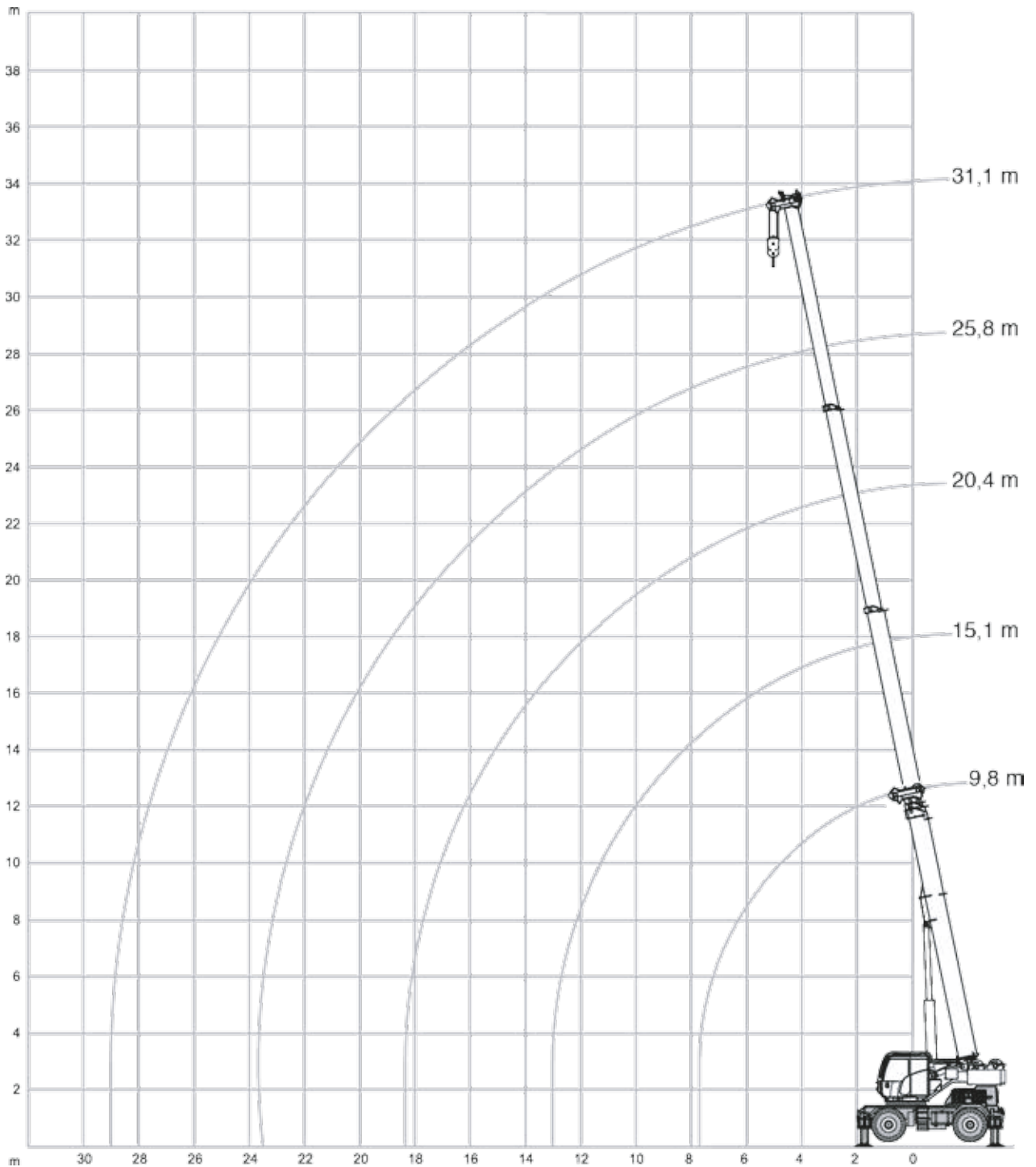
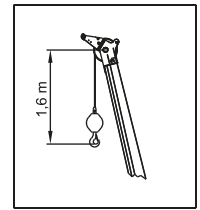
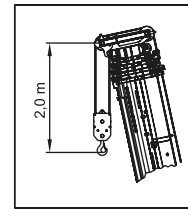

LOAD CHART – MAIN BOOM

RT 1045

DIAGRAMMA DI CARICO · TRAGLASTTABELLE · GRAPHIQUE DE CHARGE ·
TABLA DE CARGA · TABELA DE CARGA · ТАБЛИЦА НАГРУЗОК

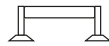

**Outriggers Fully Extended (100 %) · Stabilizzatori completamente estesi (100 %) ·
Abstützungen voll ausgefahren (100 %) · Stabilisateurs entièrement déployés (100 %) ·
Estabilizadores totalmente extendidos (100 %) · Extensão máxima dos estabilizadores
(100 %) · На полностью выдвинутых опорах (100 %)**

 5,5 t

 6,00 x 6,20 m
(100 %)

 360°

European Standard
EN 13000

						
	9,8 m	15,1 m	20,4 m	25,8 m	31,1 m	
m	t	t	t	t	t	m
3,0	45,00	25,00	17,00			3,0
3,5	34,10	25,00	17,10			3,5
4,0	28,60	25,00	17,40	10,00		4,0
4,5	25,20	25,00	17,80	10,10		4,5
5,0	22,20	24,30	16,10	12,10		5,0
6,0	18,30	19,80	14,50	12,00	6,80	6,0
7,0	15,50	16,20	13,10	10,80	7,40	7,0
8,0		12,80	12,00	9,90	8,50	8,0
9,0		10,30	10,10	9,00	7,40	9,0
10,0		8,50	8,70	8,30	8,00	10,0
11,0		7,20	7,30	7,10	6,50	11,0
12,0		6,10	6,20	6,30	6,00	12,0
13,0		5,20	5,40	5,40	5,50	13,0
14,0			4,70	4,70	4,70	14,0
15,0			4,00	4,10	4,00	15,0
16,0			3,50	3,60	3,60	16,0
17,0			3,10	3,20	3,20	17,0
18,0			2,70	2,80	2,90	18,0
19,0				2,50	2,50	19,0
20,0				2,20	2,30	20,0
21,0				2,00	2,00	21,0
22,0				1,70	1,80	22,0
23,0				1,50	1,60	23,0
24,0					1,40	24,0
25,0					1,20	25,0
26,0					1,10	26,0
27,0					0,90	27,0
28,0					0,80	28,0
29,0					0,70	29,0

Notes to lifting capacity · Annotazioni sulle portate · Anmerkungen zu den Tragfähigkeiten · Conditions d'utilisation ·
Condiciones de utilización · Notas sobre capacidade de içamento · Примечания по грузоподъемности:
see page 23 · vedi pagina 23 · siehe Seite 23 · voir page 23 · ver página 23 · ver página 23 · см. на стр. 23